

THIS NEWSLETTER IS PUBLISHED BY THE  
PORT ELIZABETH AMATEUR RADIO SOCIETY

P.O. BOX 10402  
LINTON GRANGE  
6015

**September 1998**

# NOTICE OF MEETING

The monthly general meeting of the **PORT ELIZABETH AMATEUR RADIO SOCIETY** will be held on **Friday, 18 September 1998** commencing at 20:00 (8pm) in the Municipal Disaster Management Centre, Westview Drive, Mill Park, Port Elizabeth (Civil Defence Centre).

Neil Thomas ZR2NT will enthral us with more of his experiences in the industrial field, with particular reference to noise control engineering. No doubt there will also be more questions from the audience relating to the construction and operation of off-shore oil drilling rigs.

Tea, coffee and biscuits will be available for a small consideration after the business.

## *Technical Evening*

The next technical evening will be held on **Thursday, 24 September 1998**, starting at 20:00, in the Clubhouse (Municipal Disaster Management Centre). Des Herselman will talk about switched mode power supplies, and Viv Moore ZS2VM will follow with a discussion on converting paging receivers to tune across the two metre band. An article on this will appear in QSX soon, so a preliminary look at things will be useful.

*Unless there is a reasonable turnout, this could well prove to be the last technical get-together!* Attendance at the last meeting was extremely disappointing and the event was abandoned. Perhaps the problem is that we don't seem to be talking on 2 metres so much any more and everyone forgets about our meetings. Even the general meetings have been a bit low on attendance of late. So shake a leg if you want things organised for you – if you don't support these events, nobody will want to lay them on for you.



## *Wrinkly Ravers*

The next luncheon will take place on **Thursday 1 October**. Please note that the venue will once again be the **Zwartkops Yacht Clubhouse**.

Although the past two luncheons have been most enjoyable, there is just that *something* about the ZYC venue – Perhaps it's because we can first get a jump-start in the pub before proceeding to the dining room. Then, too, the spaciousness of the latter is just the job for our bunch, considering the number of wrinkly old slobs who can't laugh quietly, so we can let our hair down (well, anyway, *some* of us can!).

Get there at about 12:30 pm. and place your luncheon order while you recharge. 



## *A Word From the Chair*

*A*nother opportunity for gaining publicity and support for our hobby is being investigated and planned for right at the moment. We all know that 1998 was declared the Year of Science and Technology, and whilst it started off with a spurt, things seem to have quietened down a lot towards the middle of the year.

We in the Eastern Cape are fortunate enough to have the annual Grahamstown Science Festival as an opportunity to show our hobby off to the school-going ages. This festival was supported by Phil and Ewan, ZS2PP and ZS2EN this year, and they drew a lot of interest with their weather satellite display, as part of a larger stand put on by a local school.

Because of the success, PEARS will support a display purely for amateur radio at the 1999 festival, to be held on 17<sup>th</sup> – 23<sup>rd</sup> March. I have already made application for an area for our stand, and would like to appeal for assistance in getting a professional display together. Whilst March may seem like a long time away, we lose a lot in the Christmas holidays, so time is not too plentiful.

ECARES will also have a good publicity opportunity by possibly staging daily demonstrations of how they can interact with other rescue services, and the invaluable assistance radio amateurs can offer during disaster situations.

Finally, how about a great social get-together, with good company, new faces, familiar voices, great scenery, a good fire, and good refreshments? Then let's see you at the QTH of Roger, ZS1J, in November when we have an "expedition" down to the Plettenberg Bay area. Looking forward to seeing you and your family there!

73,

*Chris,* **ZS2AAW**

Saturday, 15th August was the big day for the naming of the Boeing 747 at the Port Elizabeth airport. It was a pretty miserable day with strong, cold wind and it rained most of the morning, all of which put a bit of a damper on the proceedings. There are always those who are not easily discouraged, however, so there was a fair crowd in attendance.

Despite the forebodings of some skeptics regarding the landing of the Boeing at the PE Airport, it landed with ease and with plenty of runway to spare. It was duly named *Ibhayi*, took some privileged people on a forty minute flip and later flew back to Johannesburg. We were also entertained to aerial acrobatics by some small planes.

Hamnet/ECARES members set up station to handle communications for any

possible emergencies and monitored two metres, forty metres and the aeradio channels.

Amateurs involved were Jason ZR2BHG, Neil ZR2NT, Nicolas ZR2NDT, Alex ZR2T, Anne ZR2XT, Stoffel ZS2C, Mervyn ZS2F, Ken ZS2OC, Al ZS2U and Jo ZS2W. There were others monitoring further afield as well, notably Gary ZR2LG at The Crag.

Fortunately there were no mishaps and proceedings went off well despite the inclement weather.

73

**Al Akers ZS2U**  
**Provincial Director,**  
**Hamnet East Cape/ECARES**

---

## Morse disappearing from the high seas

(FROM AMATEUR RADIO NEWSLINE)

(Lifted with thanks from *QUA*, Bloemfontein ARC Newsletter)

Morse code will disappear from the high seas as of March 1, 1999. This is the date when all passenger ships and cargo ships over 300 gross tons will no longer be permitted to use Morse code for distress calls.

The International Maritime Organization says that Morse is being phased out because of its many drawbacks. These include the need for years of training and practice for operators to use it. The IMO says that, if something happened to the radio operator, it is unlikely that anyone else on board a ship would be able to use the telegraphy equipment. The IMO says also that other reasons for the phase-out of terrestrial CW include reception problems, uncertainty about the accuracy of messages received using Morse and the airwave congestion that came with the development of radio on land.

*Wired* magazine reports that the use of the Morse code in maritime communications will be taken over by a network of geostationary communication satellites. Two are positioned over the Atlantic Ocean and one each over the Indian and Pacific Oceans.

Also, larger cargo ships and passenger liners will be required to carry satellite emergency position indicating radio beacon transmitters. Using these in conjunction with orbital search and rescue satellites can bring aid a lot more quickly to a stricken vessel than listening in the noise for an SOS signal in Morse code.

❑ Wonder if they heard about the *Oceanos* – it had a lot of highfalutin' satellite equipment, but the ship listed too badly to point to their chosen satellite and they had to use CW to shout for help!



# G'TOWN REPEATER WOES

Most regular users of the Eastern Cape's famed linked repeater system will be aware of the crackling that has often been heard of late. In a visit to the installation recently, Chris ZS2AAW found that the noise occurred on a signal at the repeater input when RF was applied to the colinear antenna. It was relayed over the whole network,

Tests with a temporary quarter-wave antenna proved that the fault was in the colinear antenna itself, and not in the feedline or connections. The colinear was brought back to PE for attention and has probably been reinstalled at the repeater site by the time this issue of QSX reaches you.

During the visit, Chris also replaced the UHF equipment on the link to East London to convert the operation from single-frequency to split-frequency mode. This will enable users at the East London end to break in more easily, since they will not have to wait for a tail elsewhere on the system to drop out before they can 'turn the repeater around'.

Unfortunately, Murphy was on site and the transmitter was found to have zero output. Quickly re-installing the original unit, Chris hoped that the EL chaps had not yet replaced *their* end with matching split-frequency UHF equipment. They *had*, however, so the link to EL remained unusable until Chris could get a working unit back up there.

Another reason for the UHF channel change was to accommodate a future 9600 baud packet backbone link between Port Elizabeth and the Grahamstown rose switch. This will provide the rural packeteers with better comms with ZS0NTP and, at a future date, enable East London to access ZS0NTP as well.

Chris also installed a DTMF controller at Grahamstown to enable the VHF repeater to be removed from and restored to the linked repeater system, leaving the rest of the link to EL unaffected. The code is 7500 followed by # to disconnect and \* to reconnect. While removed from the link, it continues to function as a 'local' repeater. 

## CAN YOU HELP OUR YOUNG OPS?

Nicolas Thomas ZR2NDT, Chairman of the Newton Amateur Radio Club, tells us that the lads at Newton Technical High have negotiated a dedicated room (the projection room) for their radio activities. In the past a room in the electrical workshop was used but it restricted access for non electrical students. They also anticipated problems with all and sundry fiddling with their equipment.

To help them get started they are looking for transformers – 220V/15V, approx 180 VA for power supplies. 24V transformers will also do as they can remove some of the windings to get the secondary voltage down.

They also appeal for any unused PRC261 ex military sets for three of the hams at the school. These sets are crystallised up for a few channels in the 6m band and at 1/3 Watt only draw approx 250mA – ideal for them to start on with very little cost.

If you can help, please get in touch with Nicolas or his Dad, Neil Thomas, at [041] 72-1969.

# OLD AGE IS GOLDEN

AN ODE TO WRINKLY RAVERS

Dennis Green ZS4BS enjoys reading about the wild goings-on of our Wrinkly Ravers and sent us this poem, which he thought might have some relevance!

**T**here is nothing the matter with me,  
I'm as healthy as can be,  
I have arthritis in both my knees  
And when I talk I talk with a wheeze.

My pulse is weak and my blood is thin,  
But I'm awfully well for the shape I'm in.  
Arch supports I have on my feet,  
or I wouldn't be able to be on the street.

Sleep is denied me, night after night,  
But every morning I find I'm alright.  
My memory is failing, my head's in a spin,  
But I'm awfully well for the shape I'm in.

The moral of this as this tale unfolds,  
that for me and you who are growing old:  
It is better to say: "I'm fine" with a grin,  
than let folks know the shape we're in.

How do I know that my youth is all spent?  
Well my "get-up-and-go" has got up and went.  
But I really don't mind, when I think with a grin,  
Of all the great places my "get-up" has been.

Old age is golden, I have heard it said,  
But sometimes I wonder as I get into bed;  
With my ears in the drawer, my teeth in the cup,  
My eyes on the table until I wake up.

Ere sleep comes o'er me, I say to myself,  
Is there anything I should lay on the shelf?  
When I was young my slippers were red,  
I could kick my heels right over my head.

When I grew older my slippers were blue,  
But I could still dance the whole night through.  
Now I am old my slippers are black,  
I walk to the store and puff my way back.

I get up each morning and dust off my wits,  
Pick up the papers and read the "OBITS";  
If my name is still missing, I know I am not dead,  
So I get a good breakfast and go back to bed.

■ *Thanks, Dennis. I haven't reached that stage yet, but I'm sure it applies to some of our Wrinkly Ones – see below!*

**And now...**for our over-the-hill readers who haven't heard that Peggy Moore, XYL of ZS2VM, distributes many outstanding health products, we introduce...

***Mrs Moore's Miracle Muti for middle-aged males and Mrs Moore's Magnificent Moisturizer & Make-over for menopausal matrons.***

Both of these products are extracts from **carefully selected dung-beetle kidneys**

and other **high-grade natural bug juices**, blended in a **fully automated process**, so they are **completely untouched by human hands!**

□ *Pictured here is Ken Tremeer, ZS2BWB, Chief of the Wrinkly Ravers, seen (left) before using Mrs Moore's Miracle Muti and (right) after just a few delicious doses.*

*...or was it the other way round?*



# MINUTES OF THE MONTHLY GENERAL MEETING OF THE PORT ELIZABETH AMATEUR RADIO SOCIETY, HELD AT THE MUNICIPAL DISASTER CENTRE, MILL PARK, PORT ELIZABETH ON FRIDAY, 21 AUGUST 1998

**Present & Apologies** : As per the register (18 members attended in unpleasant weather).

**Opening** : Chris ZS2AAW opened the meeting and welcomed all.

**Minutes of the previous meeting** : Acceptance proposed by Lynne ZS2MM, seconded by Shaun ZR2SC.

**Matters arising** : None.

**Finance** : Clive ZS2RT said that all is well and that the investment was growing well with the high interest rates.

## **Correspondence :**

1. A questionnaire from S.A.R.L. of a general nature.
2. An invitation to exhibit at the Grahamstown Science Fair which was discussed and agreed to.

## **General :**

1. A proposal was made that all new members should be introduced to club members. They should be invited to tell us something about themselves, thus helping all to get to know each other.
2. Proposed new PEARS VHF / UHF contest: Feedback was given on the progress made in this regard.
3. The Lighthouse Weekend on 22/23 August 1998 drew no contenders . Bill ZS2ABZ had offered to put up a station at the Cape Receife lighthouse but was not able to secure the necessary permission.
4. Shaun ZR2SC was complemented by Lynne ZS2MM for calling in ladies first on his Sunday bulletin.

**Closure** : The chairman closed the business section of the meeting at 20H35 after a VW rally feedback session.

Neil Thomas ZR2NT then took the floor to give a talk and slide show on noise control design in industrial environments, with particular reference to oil drilling rigs in the design of which he had been involved. From the many questions asked, the talk was clearly well received and interesting.

Tea and biscuits were served thereafter.



---

## **MORSEWORD: Solution to puzzle on page 4 of the August issue:**

**Across:** 1 Stage, 2 rob, 3 lib, 4 fire, 5 hart, 6 saint, 7 impi, 8 goes, 9 kilt, 10 view.

**Down:** 1 hip, 2 peel, 3 Vic, 4 giant, 5 real, 6 merge, 7 oven, 8 does, 9 hist, 10 swim.

# A Variable Power Bench Supply with Current Limiting

BY ANDRÉ BOTES ZS2ACP

If you are at all interested in electronic home construction you would require a voltage source and if this source could be varied and stable it would be ideal.

Some time ago Mike Morgan furnished an article explaining the use of the L200 as an effective NiCad charger. This got me thinking about something I had read, where this device was used as a voltage and current regulator in a bench supply.

As far as can be ascertained the

specs are 3 to 30 volts at 2 amps. This is well within the requirement of 90% of homebrew projects.

In order to protect both itself and the circuit it is connected to, it is essential that some form of current limiting is applied. The L200 can limit from 10mA to 2A.

## COMPONENTS

R1 1k	C1 4700mfd. 50v
R2 1k	C2 220n polyester
VR1 10k wirewound	C3 100n polyester
VR2 50k wirewound	C4 47mfd. 50v
On/off switch.	500ma. fuse and holder.
D1-D4 diodes or diode bridge to handle 2 Amps	
D5 Red LED	
Veroboard (about 2,5" x 1", or 65mm x 25mm)	
Transformer: between 15 and 20 volts. (Remember that when the DC is smoothed by C1 the voltage increases by 1,4 times.)	

One could increase the current handling capacity by using this unit to drive a 2N3055 with resultant changes in current limiting. With a 2N3055 gain of say 20 the current limiting would be 200mA to whatever the 2N3055 can

give.

With this modification (see Figure 3) one would have to increase the transformer VA rating, the size of C1 to about 10000  $\mu$ Fd and the diodes or bridge to about 6 amps.



## Instant Printing

FOR ALL YOUR  
PRINTING REQUIREMENTS

9 St. Patricks Road, Port Elizabeth 6001

Telephone: (041) 55-2614

Try us for your QSL cards!





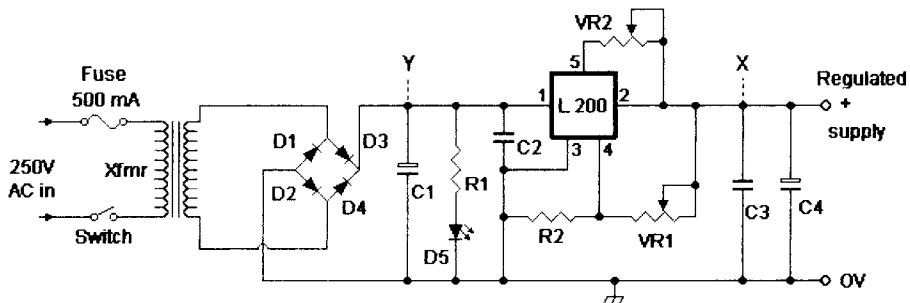

Figure 1

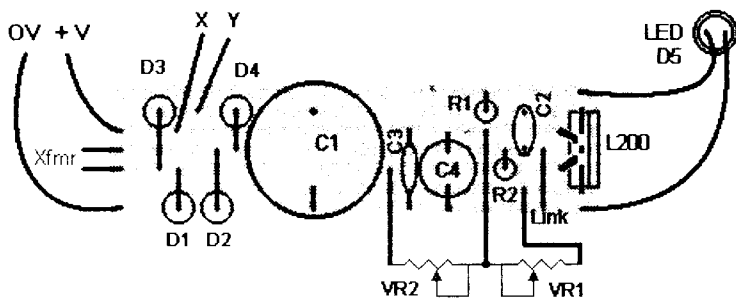

Figure 2

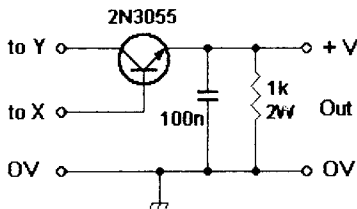
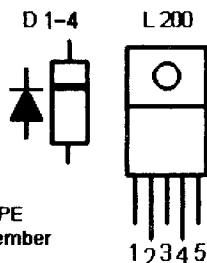

Figure 3 (Optional - see text)

QSX-PE  
September  
1998

## FOR SALE \* WANTED \* SWOP

### FOR SALE

- \* Eland 5-channel VHF mobile transceiver (requires crystals); Autodek 20 Amp 13,8 Volt power supply—Theunis Potgieter, ZR2TP, tel. 41- 5209.
- \* Megapower VHF transceivers 25 Watt 12 Volt, 6 channel (require crystals)—Vic Olivier, tel. 360-2440
- \* Yaesu FT707 transceiver, good condition, R1200 o.n.o.—Ben Schilder ZR2ABE, tel. 360-0392.

# HAMNET SIMULATED EMERGENCY CONTEST RESULTS

5th April 1998

It is gratifying to see an increased involvement of amateurs in this year's contest. We hope next year will be even better.

	<u>1997</u>	<u>1998</u>
Logs sent in	11	14
Stations participating	15	28
Stations involved	60	70

Congratulations to the winners, who were:

Category A (single operator stationary mobile)	ZS5VE
Category B (single operator portable)	ZS2U
Category C (multi-operator portable)	ZS6RTB
Category D (single operator base station)	ZS6AKI

Full results are:

<u>Category A</u>		<u>Category B</u>		<u>Category C</u>		<u>Category D</u>	
ZS5VE	720	ZS2U	1953	ZS6RTB	2478	ZS6AKI	1404
ZS6COL/5	500	ZS6ARV	1440	ZS5ZLB	828		
		ZS2OC	1242	ZS6GBJ	660		
		Z21PE	864	ZS5WP	560		
		ZS2MW	4				

While the main purpose of these contests is to enable members to assess their operating abilities and their station efficiencies, they are also meant to be social/fun events. Comments from members help to make the contests effective and enjoyable. Here are some:

*ZS2MW:* Although only one contact was made, due to my control board coming loose, I was still a formal entrant.

*ZS5ZLB:* Most enjoyable. We enjoyed a very pleasant braai/social after the contest.

*Z21PE:* Generally first class experience plus bonus of getting Zimbabwe on the map re Hamnet activities. Lovely time had by all and especially the /R operators getting first hand exposure to H.F. conditions. Bonus of activating the special event callsign Z21PE for celebrating centenary year of Prince Edward school. Suggestion that we include message relaying. We will give this some thought.

Certificates will be issued in due course. It is unfortunate that categories A and D are not eligible due to there being fewer than three entrants.

# PEARStalk

## **SARL GM RETIRES**

Len Silberman ZS6BYE is stepping down as General Manager of the SA Radio League. According to the SARL's bulletin of 9 August, Michelle van der Merwe ZS6TO has been appointed as the League's new Administrative Officer as from 1 September and will take over all administrative duties from Len.

Michelle was elected as a Councillor at the recent SARL AGM and will therefore henceforth wear two hats, as did Len.

Since the bulletin said nothing to the contrary, we assume that Len will continue to serve Amateur Radio as a Councillor, but he will now have a little more time to attend to his other interests as well.

We bid Len a fond farewell as GM, and thank him for a difficult job performed under difficult circumstances during a difficult period in the League's history.

## **WORLD'S OLDEST HAM DIES**

Australia's and, by all accounts, the World's oldest amateur, Harry Angel VK4HA, became a silent key on 16 August at the age of 106.

Harry had been a ham for 63 years and an active Dxer until his 100th birthday, preferring the ragchew to the '10 second QSO'.

## **SARL BUILDING**

The SARL has accumulated nearly R250 000 in its building fund and expects the construction of phase 1 of the HQ building to start soon. A 30 year lease for use of the property was signed by Sentech and the SARL recently.

Another R50 000 is required if the first and second phases of the building are to be completed in one project. A number of

pledges have been made but are still outstanding, and the League appeals to all who have promised contributions to the fund to send their remittances as soon as possible.

## **PEARS INITIATING NEW SA CONTEST**

A new national VHF/UHF contest has been conjured up by Mike Bosch ZS2FM and the Society has agreed to adopt it as a PEARs event.

Greatly simplified rules have been put in place to level the playing fields and move the goalposts to where they can be reached more or less equally by all players, no matter what their location is in South Africa.

There is also a category to empower those entering at grass-roots level – i.e. the disadvantaged hams with low-power, FM-only rigs – to qualify for an award at the end of the day – or weekend, to be more precise.

Seriously. Moreover, the best time of the year for long-distance VHF/UHF contacts has been selected, with the great possibility of good 'openings' producing some really exciting QSOs.

More details will be announced as the time approaches.

## **SUNDAY OUTING TO PLET**

It is proposed to arrange an outing for all hams along the Eastern and Southern Cape early in November – either the first or second Sunday (1 or 8 November). The intention is to gather for a day of ragchewing and braaiing at the farm of Roger Davis ZS1J a few kilometres west of Plettenberg Bay.

Those who participated in a similar

event a couple of years ago will no doubt be anxious to do it again this time.

The proposal will be raised at the September meeting of PEARS.

### **BORDER RADIO CLUB AGM**

At the Border Radio Club AGM held on 23 August, Colin Robertson ZS2CR was elected as Chairman, having had a respite from this position for a year or so while Gerald ZR2GB held the reins. Gerald has not been freed of all responsibilities, however – he accepted re-election to the Club's Committee.

Congratulations, Colin and all committee members. We wish the BRC a happy and successful year ahead.

### **HONORARY MEMBERSHIP FOR 2 EL HAMS**

The BRC has bestowed honorary life membership on two of its long-standing members – Tiny Smuts ZS2GN and Stan Geer ZS2KV.

Both of these members have given many years of support to the Club and its fore-runner, the East London Branch of the SARL. Both served for many years on the Committee and, if memory serves me well, had various terms as Chairman and Vice Chairman respectively. They certainly deserve the honour, and PEARS congratulates them.

### **WIN CONTESTS WITH COURTESY?**

Encouraging listeners to participate in the recent SARL CW contest, an SARL bulletin urged inexperienced operators to "listen to the experts. You'll hear some slick operators...and you'll hear some operating practices that you will definitely not want to emulate."

That's very true! The advice continues: "Learn from the courteous and efficient operators, and you'll see how your own operating style changes for the better."

Well, that is true under ordinary

operating conditions but, if you want to win a contest, you cannot afford to pussyfoot around or show any courtesy to other participants. It's very much 'every man for himself' and, if you want a top score, you have to climb in boots and all, leaving the opposition no room to get a toe into the door.

Which gives rise to the question – do contests encourage inconsiderate operating? Do some operators deliberately drive their rigs into distortion to cause splatter for others?

At best, contests give participants experience in copying one another under conditions of serious interference, so there is a positive side. And, of course, they bring many operators out of the mothballs into which they seem to creep between contests!

### **WORLD AMATEUR RADIO DAY**

World Amateur Radio Day will be celebrated on 19 September. The event will honour the first two-way trans-oceanic amateur radio contact made on 27 November 1923 between French station 8AB and American stations 1MO and 1XAM on a frequency around 2,7 MHz.

These contacts were soon followed by many others and the activity ushered in the short-wave era. The rest is history, and for some absorbing further insight into this fascinating time in the development of our hobby, be sure to read Mike Bosch ZS2FM's article VHF-UHF-SHF in the *October* issue of *Radio ZS*.

A special event station using the call sign GB100AR will operate from the RSGB Headquarters in the UK on 19 September to celebrate both 100 years of amateur radio and the first trans-oceanic two-way contact 75 years ago.

### **LAST CHANCE FOR RALLY CLAIMS**

The September meeting will be the last opportunity that members will have to

lodge a claim for fuel expenses incurred in connection with assistance given with VW Algoa rally comms. If you wish to claim a refund of your expenses, please contact Clive ZS2RT, *preferably before the meeting* so that he can draw nog geld and have an envelope ready for you.

After the meeting, the Society will bank, as PEARS funds, the rest of the donation that the Organizers kindly made in appreciation of the services that the Society rendered.

## MEMBERSHIP FIGURES

The Society currently has 122 paid-up members. A few members from last year have not yet renewed their subs, but some will probably do so when they get around to it! We were going to print a round tuit in QSX for them, but we only have a square one in stock at present.

The last indication we had of SARL membership was 1120 renewals for the current year, which is considerably down from last year's total. If you have not yet renewed your SARL membership, they will be glad to receive your remittance as soon as possible.

## WHERE HAVE ALL THE LADIES GONE?

A lovely lot of ladies logged on after Shaun ZR2SC's bulletin in August and this drew a lot of appreciative comment from other loggers-on. However, when the girls were invited to call in first again the next week, there was an almost deathly silence.

Does this mean that we should appoint Shaun as our *permanent* bulletin reader?

What has *he* got that we don't have, apart from a melodious voice?

## IS YOURS LEMNISCATE?

Did you know that the main radiation pattern of your dipole probably approximates a lemniscate, that is a plane curve

in the shape of a figure eight traced by the foot of a perpendicular drawn from the origin to a tangent to a rectangular hyperbola: the locus of the vertex of a triangle when the product of the two adjacent sides is maintained equal to 1/4 of the fixed opposite side?

You *didn't know that??* Well, you'd better get *with it buddy!!*

## HONORARY LICENCE FOR PRINCESS

The Thai authorities have granted Princess Sirinthan of Thailand an honorary call sign HS1D. This should be a greatly sought-after operator and she will no doubt be swamped with calls whenever she appears on the band, as King Hussein of Jordan JY1 (no suffix, just the prefix) has been.

Incidentally, a recent news broadcast mentioned that JY1 has been undergoing medical treatment and we hope that it will prove to have been successful.

## GARY ZR2ABU IN ARMED HEIST

Gary Laaks ZR2ABU had the misfortune of being on duty when the Linton Grange Post Office was hit by armed thugs on 4 September – for the third time in a few short months.

Seeing the robbers jumping over the counters, Gary tried to hide the bundles of high-value notes but, before he could get them out of sight, one of the thugs arrived at his cubicle brandishing a handgun.

Fortunately neither Gary nor any of the other staff members was injured, although some were badly shaken.

## BEACON ON 30 METRES

Roger ZS1J has installed a half-watt beacon on about 10,103 MHz. Reports indicate that it has been heard in PE and elsewhere in the RSA.

The frequency is in a popular CW area but is sure to change when Roger receives a proposal from the IARU. 

**Condolences**— We extend our condolences to John Morris ZS2MD on the passing away of his wife late last month.

## ***Congratulations...***

### **on your birthdays:**

#### **September**

- 20 Pierre Knobel ZS2ABC
- 20 Martie vdBerg XYL of ZS2VV
- 26 Joors Trooly ZS2HB
- 27 Ewalt Bouwer ZS2EHB

#### **October**

- 6 Colin Ashwell ZS2AO
- 8 Vanessa Scarr ZR2VM
- 8 Raphey Schauder ZS2SP
- 8 André Oliphant ZR2BC
- 9 Pamela Koen XYL of ZR1JAC
- 9 Ewan Mathieson ZS2EN
- 12 Neil Thomas ZR2NT

### **on your anniversaries:**

#### **September**

- 22 Anne ZR2ABC & Vic Olivier ZS2SZ
- 23 Joey & Des Pettit ZS2ABU
- 28 Marjorie & Dudley Forsyth ZS2AW

#### **October**

- 9 Kay & Fred Strutt ZS2JS
- 10 Joan & Bill Browne ZS2BY
- 13 Louise & Pierre Knobel ZS2ABC



***Welcome Home:*** Kevin Hopper ZR6TG, son of Pam and Phil, who has returned to Port Alfred and, we believe, will be taking up a position at the Air School. Glad to have you back in our neighbourhood, Kev.

***New Member:*** Margaret France ZR2BCG, XYL of Jim ZR2JRF, has joined the Society as a paid-up Family member in her own right. FB, Margaret!

***Commiserations*** to Mike Bosch ZS2FM, whose car was wiped out in a side-on collision. He, XYL Susan and son Robert ZR2ABK were lucky not to have been seriously injured but they were a little sore for some time after the prang.

***Gadding About:*** Merle Thomas ZR2MP, Neil ZR2NT, Nicolas ZR2NDT, Adele Thomas and two friends of Adele and Nicolas are travelling to Pofadder on 23 September to do the Namakwaland 4X4 trail. The route starts at Pofadder, thence to Pelladrift, follows the Orange River to Kraphol Island, Grootmelkboom, Kamgab, Stofbak-kies, Violdsdrift, Helskloof, Bak-kranse, Holgat, Sukkel and ends at Alexander Bay. From there they travel to the Richtersveld National Park which includes Pootjiespram, Sendelingsdrift, Richtersberg and Koker-boomkloof. All of this in a 1974 Land Rover!

Good luck, you-all.

Glad I'm not going. I mean, how could I ever talk about that *route* without falling about the floor? 

## Your Society's Committee

Chairman, Repeaters, Packet .....	Chris Scarr ZS2AAW	38-1344
Vice Chairman, Social, Special Events .....	Dick Schönborn ZS2RS	38-5070
Secretary, Repeaters, Packet .....	Jacques van der Heide ZR2JH	73-3728
Treasurer, Assets Control .....	Clive Fife ZS2RT	32-3203
Awards, Refreshments, QSX collation .....	Bill Hodges ZS2ABZ	51-2580
QXSX Editor .....	Garth Laaks ZS2HB	38-1101
e-mail the Editor at .....	glaaks@iafrica.com	
Assisting QXSX collation/distribution .....	Trevor Scarr ZS2AE	32-1746
Technical Classes, Social .....	Shawn Corder ZR2SC	360-7369
Librarian .....	Des Herselman ZR2DH	54-2911 (W)
		Cell 083 261 5402 (All Hrs)

## PEARS' VHF & Other Services

### REPEATERS

Town VHF .....	# 145,050/650	Kareedouw .....	† 145,125/725
Town UHF .....	# 431,050/438,650	Knysna .....	* 145,075/675
Cockscomb .....	145,000/600	Lady's Slipper .....	* 145,100/700
Cradock .....	* 145,050/650	Uitenhage .....	# 145,075/675
Grahamstown .....	* 145,150/750	Theescombe .....	† 145,175/775

\* These form PE's long-range 2-metre repeater system, to which the East London 145,125/725 MHz repeater and the George repeater on 145,100/700 are also linked. # These can also be linked as required.

† These are privately owned repeaters and are not included in the PEARS linked repeater system.

### OTHER SERVICES

Packet Bulletin Board (ZSØNTP) .....	144,625
Packet Rose Switch ZSØGHT-3,046101 (144,675 in/out) or 046102 (UHF out to BBS) .....	144,675
2m Beacon (ZS2VHF CW ID) (horizontally polarized, 160W ERP) .....	144,410
6m Beacon (ZS2SIX CW ID) (horizontally polarized, 25W ERP) .....	50,005
6m Simplex Link with Lady's Slipper 2m Repeater (vertically polarized) .....	51,400
Wefax Relay (Meteosat) .....	145,350

## Sunday Bulletins

PEARS bulletins are transmitted on Sundays immediately after the SARL English transmission, i.e. at about 08:45, on 7098 kHz as well as the 2 metre linked network that provides coverage from East London to George and environs via the linked repeater system described above. PEARS' 7098 or 3640 kHz transceive facilities are also remotely linked as needed. In addition, the SARL's 40m transmissions on 7082 or 7066 kHz, alternatively 7070 kHz, can be remotely patched into the 2m network, either in receive-only mode or for full transceive capability for interactive events.

Date	Prepare and Read on 2m Repeater link
13 Sep	ZR2JH
20	ZS2RT
27	ZS2ABZ
4 Oct	ZR2SC
11	ZS2HB
18	ZS2AAW

## DIARY DATES

### SEPTEMBER

- 18 PEARS Monthly Meeting
- 19 World Amateur Radio Day
- 19/20 SARL VHF/UHF contest
- 24 Club Technical evening

### OCTOBER

- 1 Wrinkly Rave - Yacht Club
- 17/18 JOTA

\* We Like Being Your Society! \*